

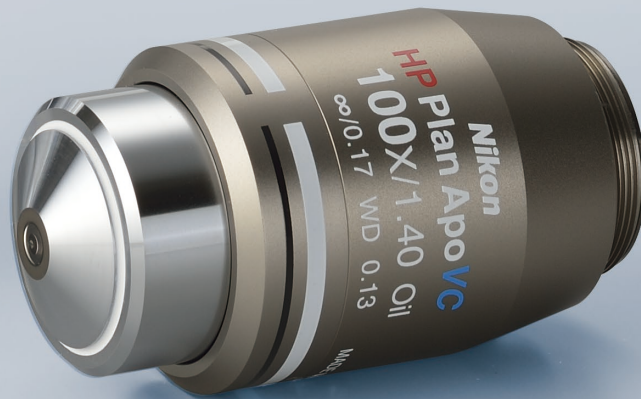

# Microscope Objectives for Bioscience



# Tireless pursuit of the highest quality

Each Nikon microscope objective is precision-crafted to provide the highest level of clarity and overall optical performance. World-class Nikon objectives, including renowned CFI60 infinity optics, deliver brilliant images of breathtaking sharpness and clarity, from ultralow to the highest magnifications.



*kiwami*

The Japanese calligraphy on the left reads as “kiwami,” which means to master or pursue excellence.

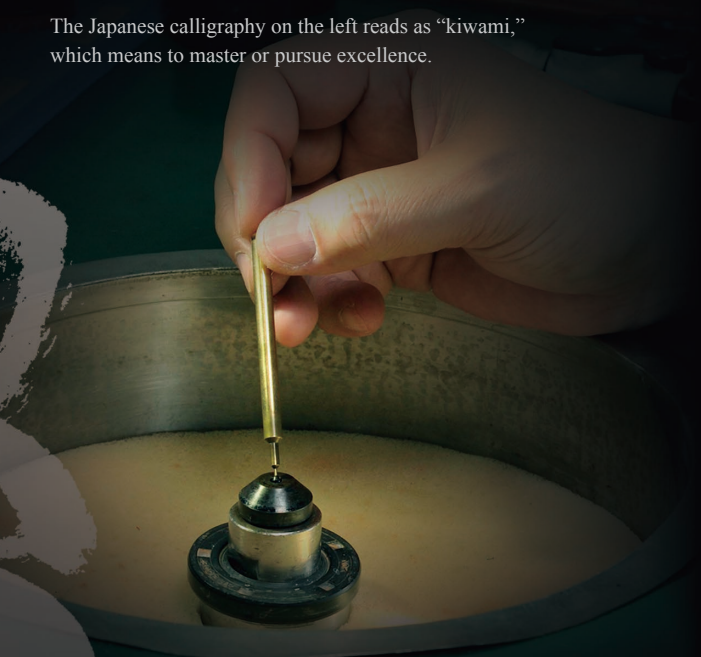

## Exceptional performance born from advanced technology in glass formation and lens manufacture

Nikon’s extremely reliable high-tech products have incorporated the company’s cutting-edge optical and precision technologies since 1917. Over the past century, Nikon has researched and developed optical glass products in combination with optical designs for cameras, microscopes, IC steppers and others.



The front lens, which is the lens element at the tip of a high-power objective, is extremely small and has a distinctive shape. The lens is made of glass that meets Nikon’s strict material standards and designed with outstanding calculations.

A highly skilled expert must grind the lens by hand to meet the required high-precision standards and desired shape. The ground lens is then stringently and repeatedly checked using high-precision processing technology to ensure it meets Nikon’s compulsory high performance.

## Nikon Master Craftperson

Within the Nikon organization, there are dedicated personnel with the title of Nikon Master Craftperson. They have passed rigorous tests and possess a high degree of skill and expert knowledge, specifically for the production of objectives. Everyday, these "masters" utilize their techniques and knowledge to deliver unrivalled glass-based optical solutions.

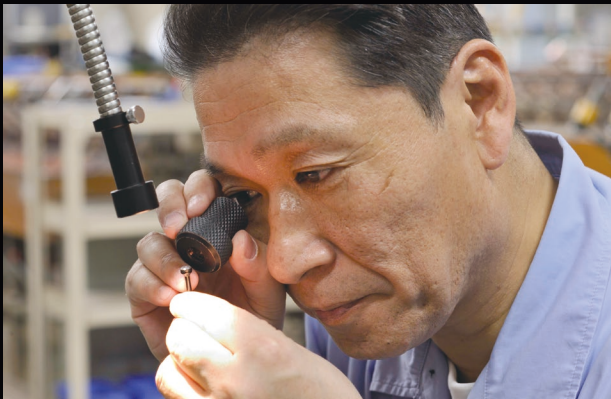

### Development of CFI60 optical system

In 1996, Nikon developed the CFI60 (Chromatic aberration Free Infinity) optical system to meet demand for superior optical performance and system flexibility of biological microscopes for sophisticated and diverse research.

By using a tube lens focal length of 200mm and objectives having a parfocal distance of 60mm with a larger diameter and a 25mm thread size, Nikon succeeded in realizing both higher NA and longer working distances than ever before.

For these revolutionary optics, both axial and lateral chromatic aberrations have been corrected independently in the objective and tube lens without the aid of other components. The 200mm tube lens minimizes shifts between light rays as they pass through the fluorescence filter cube and DIC prism, creating a smaller angle between light rays passing through the center and those off axis to dramatically improve contrast.

### A wide range of objectives to ensure reliable research results

Nikon provides the ultimate optical quality microscope objectives through highly-advanced technologies for precision optics production. These objectives offer highly reliable, high-quality images with maximum resolution and superior contrast for a wide range of applications, from routine tasks to cutting-edge bio science research.

CFI60 Optical Path  
(Conceptual Diagram)

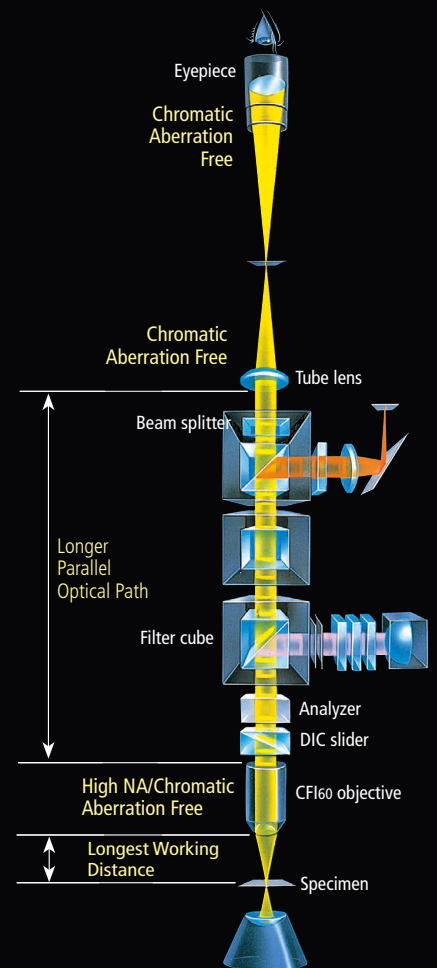

CFI60

# The innovative coating technology enables bright, highly reliable image acquisition

In today's bioscience research, it is becoming increasingly important to visualize minute cell structures and reveal mechanisms and the interaction of intracellular materials through fluorescent and confocal observations. To achieve more reliable imaging results, demand for bright objectives that can detect even the weakest fluorescent light has increased.

An objective is constructed with a number of lens elements to improve image quality and correct image distortion and aberration. However, due to surface reflection, light intensity weakens as light passes through each lens element. To reduce reflections and increase lens' transmittance, lenses are coated.

## Nano Crystal Coat is Nikon's superlative coating technology

With its origins in Nikon's semiconductor manufacturing technology, Nano Crystal Coat is an anti-reflective coating that assimilates ultra-fine crystallized particles of nanometer size. With particles arranged in a spongy construction with uniform spaces between them, this coarse structure enables lower refractive indices, facilitating the passage of light through the lens. These crystallized particles eliminate reflections inside the lens throughout the spectrum of visible light waves in ways that far exceed the limits of conventional anti-reflective coating systems.

Nano Crystal Coat eliminates ghost effects caused by red light, an achievement that has taken a long time, and effectively reduces flare effects caused by light entering the lens at an angle.

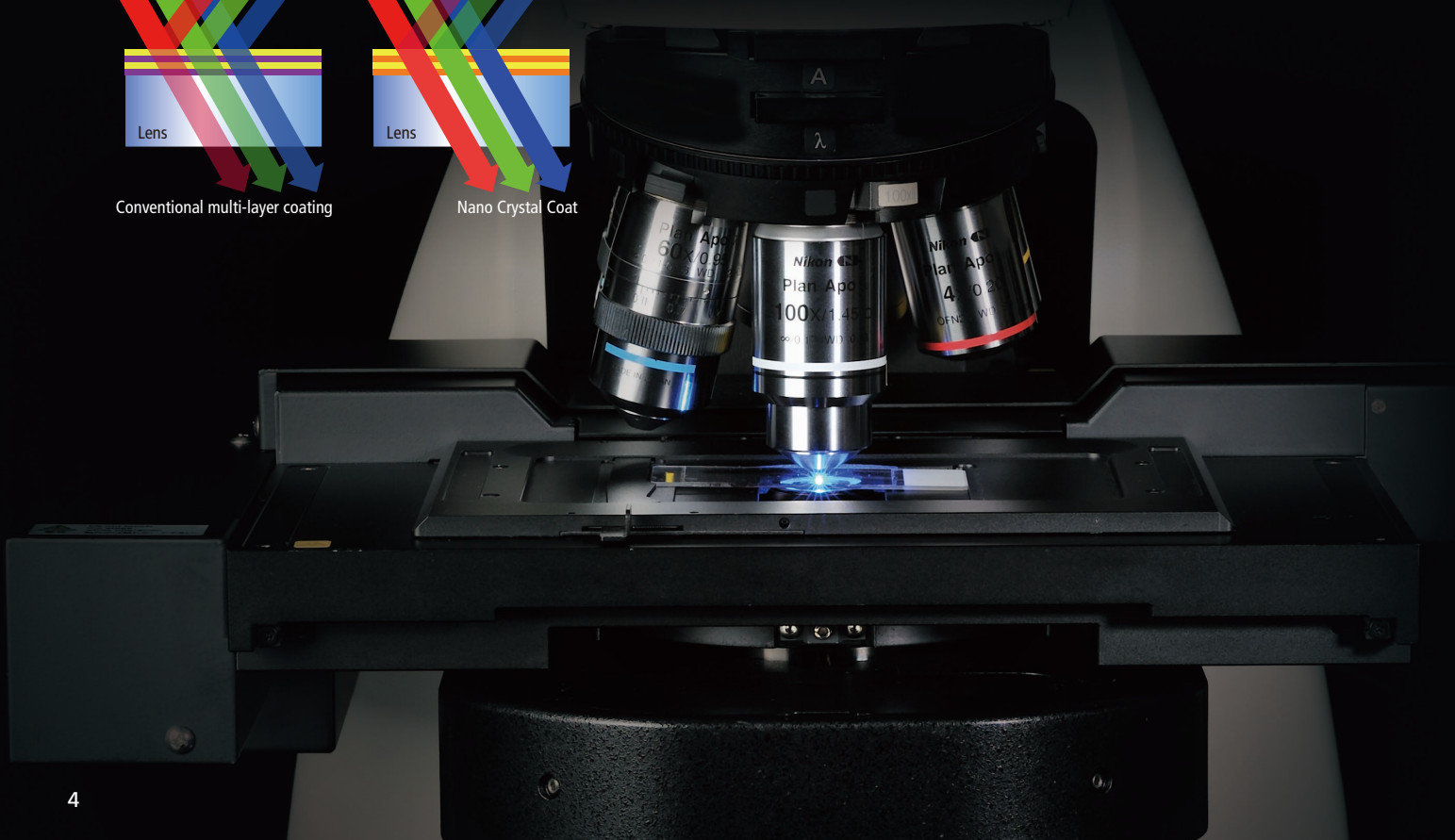
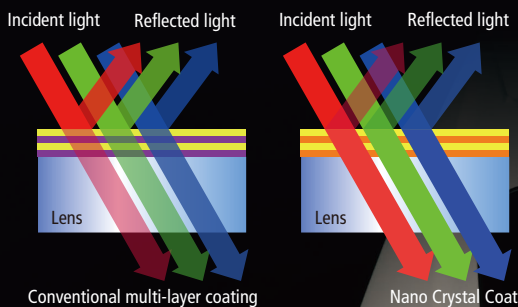
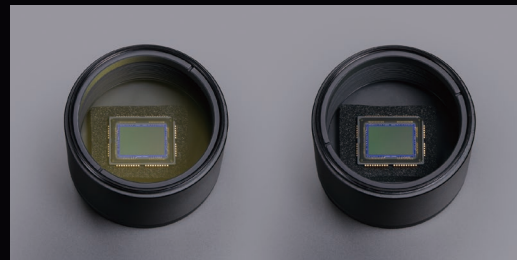

## Cutting-edge objectives with Nano Crystal Coat

These top-grade objectives employ Nikon's exclusive Nano Crystal Coat technology and provide high transmittance up to the near-infrared range. Chromatic aberrations are highly corrected over a wide wavelength range, from ultraviolet to near infrared. The immersion objectives are the perfect choice for live-cell imaging, thanks to their incomparable high numerical aperture.

### CFI Apochromat $\lambda$ S Series

These objectives provide chromatic aberration correction over a wide wavelength range from 405nm and are powerful enough for spectral imaging and simultaneous multi-wavelength acquisition. The LWD 20x/40x WI  $\lambda$ S lens has an extremely wide chromatic aberration correction range of 405nm to 950nm and is suitable for multiphoton observation. The 40x WI  $\lambda$  S lens has an NA of 1.25, the world's highest for a 40x water immersion objective. The 60x oil  $\lambda$ S lens offers high level chromatic aberration correction across the whole visible range and is a powerful tool for confocal spectral imaging and photostimulation.



CFI Apochromat LWD 20x WI  $\lambda$  S, NA 0.95, WD 0.95  
 CFI Apochromat 40x WI  $\lambda$  S, NA 1.25, WD 0.18  
 CFI Apochromat LWD 40x WI  $\lambda$  S, NA 1.15, WD 0.60  
 CFI Apochromat 60x oil  $\lambda$  S, NA 1.40, WD 0.14

### CFI Plan Apochromat IR lens

With the world's highest NA (1.27) for a 60x water immersion objective, this lens achieves a high level of resolution and sharp image acquisition. It corrects chromatic aberration up to 1,064 nm and accommodates laser tweezers.



CFI Plan Apochromat IR 60x WI, NA 1.27, WD 0.17

### CFI75 Apochromat MP lens

This lens provides a high numerical aperture of 1.10 while still maintaining a long working distance of 2.0mm. It corrects chromatic aberration up to the near-infrared range and has a ring that corrects chromatic aberrations depending on the depth of the specimen. Together with its 33° manipulator pipette access angle, it is ideal for deep imaging of live specimens using multi-photon excitation and physiology research applications.



CFI 75 Apochromat 25x W MP, NA 1.10, WD 2.00

## CFI Plan Apochromat Lambda Series

### Nano Crystal Coat guarantees optimum brightness

- Nano Crystal Coat enables remarkably high transmission up to the near-infrared region.
- Chromatic aberrations are corrected throughout a wavelength range from visible to near infrared. Bright, high-contrast images are captured during long-wavelength imaging, which is less phototoxic to live-cells.
- Unmatched chromatic aberration correction, resolution and image flatness ensure the capture of high-quality brightfield images.

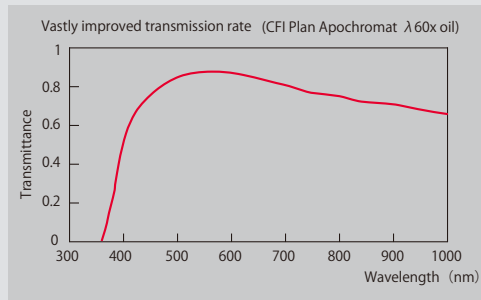

Dramatically increased transmission rates over a wide wavelength range of up to near infrared



- CFI Plan Apochromat λ 2x, NA 0.10, WD 8.5
- CFI Plan Apochromat λ 4x, NA 0.20, WD 20.0
- CFI Plan Apochromat λ 10x, NA 0.45, WD 4.0
- CFI Plan Apochromat λ 20x, NA 0.75, WD 1.0
- CFI Plan Apochromat λ 40x, NA 0.95, WD 0.21
- CFI Plan Apochromat λ 60x, NA 0.95, WD 0.15
- CFI Plan Apochromat λ 60x oil, NA 1.40, WD 0.13
- CFI Plan Apochromat λ 100x oil, NA1.45, WD 0.13

Extended chromatic aberration correction from 435 nm to 850 nm enables the capture of clear images during multi-wavelength fluorescence imaging

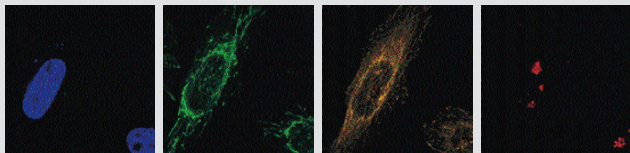
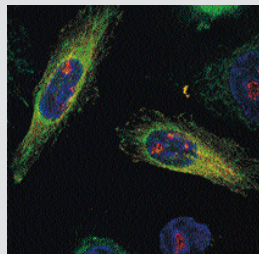

Image of HeLa cells labeled with four probes: Hoechst33342 (Nuclei, blue), Venus (Mitochondria, green), mCherry (a-tubulin, orange), Alexa 750 (Nucleoli, red)  
Objective: CFI Plan Apochromat λ 100x oil

Photos courtesy of: Dr. Kenta Saito, the Center for Brain Integration Research, Tokyo Medical and Dental University

Dr. Kentarou Kobayashi, Research Institute for Electronic Science, Hokkaido University  
Dr. Masahiro Nakano and Dr. Takeharu Nagai, the Institute of Scientific and Industrial Research, Osaka University

### Near-IR dye image

Indocyanine green (ICG) fluorescence image of mouse auricularis blood vessels

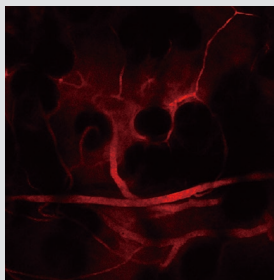

Objective: CFI Plan Apochromat λ 20x  
Excitation wavelength: 785nm  
Peak emission wavelength: 832nm

Photo courtesy of:  
Dr. Hirofumi Inoue;  
Drs. Shigeki Higashiyama and Takeshi Imamura, Proteo-Science Center (PROS), Ehime University

CFI Plan Apochromat λ 100x oil objective with 1.45 NA enables the capture of sharp images of minute structures

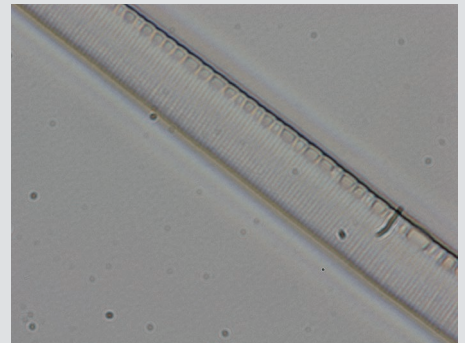

High-resolution, high-contrast images of minute structures can be acquired with high NA of 1.45.  
Specimen: Diatoms

### Three-dimensional fluorescence image

3D fluorescence image of honey bee antenna

Objective: CFI Plan Apochromat λ 40x  
DAPI: Cell nucleus  
FITC: Dorsal branch of the antennal nerve  
Rhodamine: Ventral branch of the antennal nerve

Specimen courtesy of: Dr. Hiroshi Nishino, Research Institute for Electronic Science, Hokkaido University and Dr. Takeharu Nagai, the Institute of Scientific and Industrial Research, Osaka University

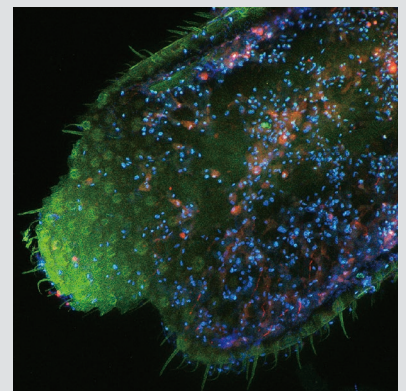

## CFI SR Series

### Objectives for super resolution microscope N-SIM

The SR (super resolution) objectives have been designed to provide superb optical performance with Nikon's super-resolution microscopes. The adjustment and inspection of lenses using wavefront aberration measurement have been applied to yield optical performances with the lowest possible asymmetric aberration.

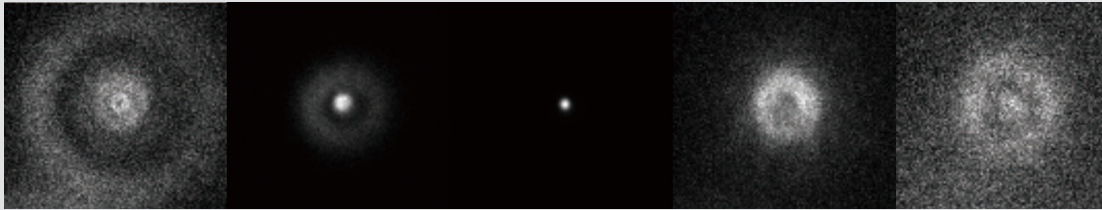

Reduced asymmetric aberration enables the capture of fluorescence bead images with even brightness during defocusing.



CFI SR Apo TIRF 100x oil  
NA 1.49, WD 0.12



CFI SR Plan Apo IR 60x WI  
NA 1.27, WD 0.18-0.16

## CFI HP Series

### Objectives for super resolution microscope N-STORM

The CFI HP (High Power) objectives are optimized for super resolution microscope N-STORM, which uses high power lasers to blink fluorophores at ultra-high speed. Thanks to the improved correction of axial chromatic aberration, these lenses enable high precision 3D multi-color fluorescence imaging.



CFI HP Apo TIRF 100x oil,  
NA 1.49, WD 0.12



CFI HP Plan Apo VC 100x oil,  
NA 1.40, WD 0.13

## Nikon super-resolution technologies that go beyond the diffraction limit

The resolution of conventional optical microscopes is limited by diffraction to approximately 200 nm. Super Resolution Microscope N-SIM/N-STORM enables elucidation of the structures and functions of nanoscopic machinery.

N-SIM can achieve an image resolution of 115 nm and a temporal resolution of up to 0.6 sec/frame, enabling super-resolution, time-lapse imaging of live cells.

N-STORM can also achieve an incredible image resolution of approximately 20 nm, which is 10 times that of conventional optical microscopes.

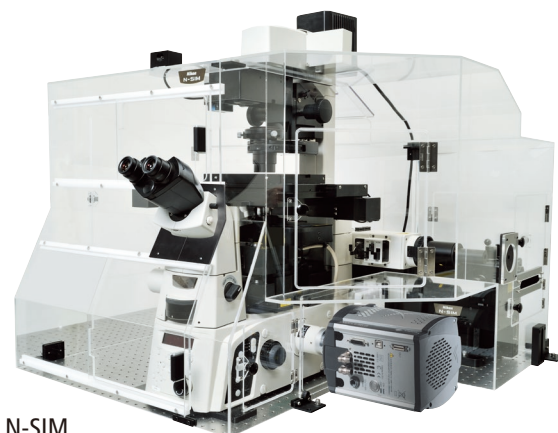

N-SIM



N-STORM

# CFI Apochromat TIRF Series

## Objectives with an unparalleled NA of 1.49

- Because of the unprecedented NA of 1.49—for use with a standard coverslip and immersion oil—these objectives enable the acquisition of bright, high S/N ratio images; so they are suitable for TIRF observation and live cell imaging.
- Both the 60x and 100x lenses utilize the spherical aberration correction ring to reduce deterioration in image quality caused by deviations in cover glass thickness or temperature fluctuations and provide optimal optical performance even at 37°C.
- High NA and the correction ring allow the acquisition of high-resolution, high S/N ratio images during TIRF observation, epi- fluorescence and confocal observation, as well as Nomarski DIC observation.
- The 100x objective can be optimally applied for laser tweezers microscopy.

Much higher S/N ratio than a conventional model  
Sample: Q-Dot

CFI Apochromat TIRF 100x oil, NA 1.49 (new product)

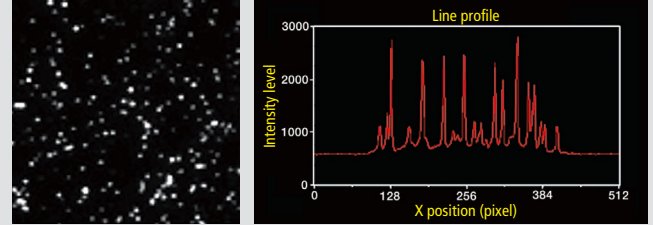

TIRF image

Intensity distribution of fluorescence signal

CFI Plan Apochromat TIRF 100x oil, NA 1.45 (conventional product)

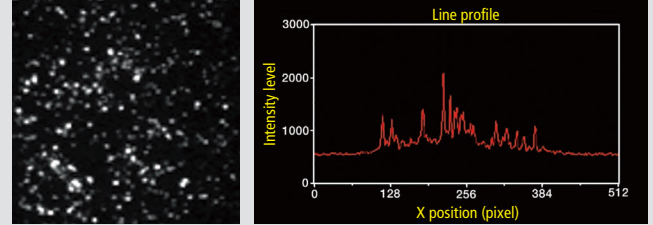

TIRF image

Intensity distribution of fluorescence signal



CFI Apochromat TIRF 60x oil, NA 1.49  
CFI Apochromat TIRF 100x oil, NA 1.49

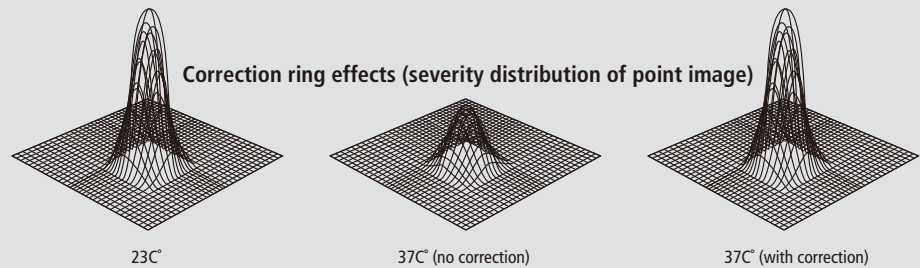

## TIRF for high-sensitivity fluorescent images with great signal-to-noise ratio

Nikon’s high NA TIRF objectives make it possible to introduce laser illumination at an incident angle greater than the critical angle ( $\theta_c$ ) for TIRF (Total Internal Reflection Fluorescence). In TIRF observation, light no longer propagates through the specimen, but sets up an evanescent field at the coverslip/specimen interface that can excite fluorescence in the specimen in an optical section less than 100nm. By exciting such a thin section within the specimen in contact with the coverslip, extremely high S/N data can be acquired.

### Overview of Evanescent Wave Illumination

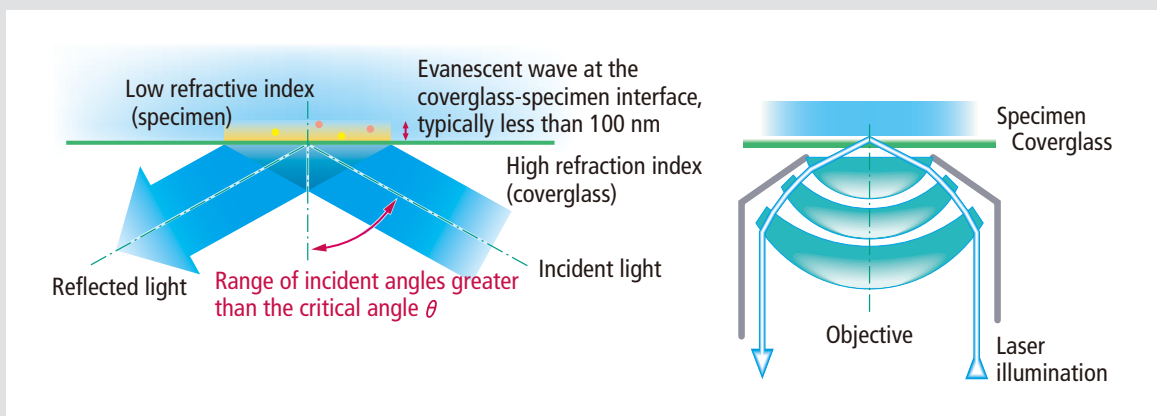



## CFI Plan Apochromat VC Series

### Essential for confocal observation such as DAPI

- Top performance objectives with perfect correction of chromatic aberrations in the visible light range and excellent resolution throughout the view field.
- Perfect choice for multi-stained, fluorescence specimens and for brightfield and DIC observation.
- In addition to the correction range of the conventional Plan Apochromat series (435–660nm), axial chromatic aberration has been corrected up to the violet range (405nm), making these objectives highly effective for confocal applications.
- Observation of images with excellent brightness throughout the view field by minimizing the light loss around the edges and increasing resolution—a critical criterion for digital-image capturing.
- The 60x water-immersion type features high spectral transmittance, even in the 360nm wavelength ultra-violet range, making it perfect for fluorescence observation of living organisms.



CFI Plan Apochromat VC 100x oil, NA 1.40

CFI Plan Apochromat VC 60x WI, NA 1.20

CFI Plan Apochromat VC 20x, NA 0.75

Water-immersion type CFI Plan Apochromat VC 60x WI objective is perfect for confocal observation of deep tissue

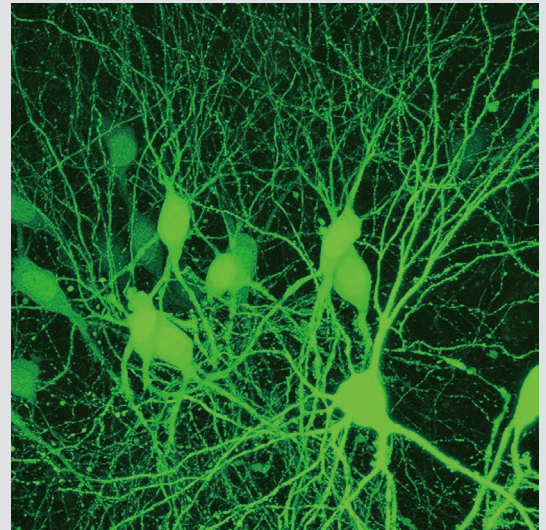

Overlaid consecutive cross-sectional scan within 108µm thickness range of a brain slice with neuronal cells expressing GFP.

Photo courtesy of:  
Tatsuya Umeda, Department of Neuroanatomy, Faculty of Medicine,  
Yokohama City University and Dr. Shigeo Okabe, Department of Cellular  
Neurobiology, Faculty of Medicine, Tokyo University

### Comparison of conventional objectives and VC objectives

With the conventional objective, DAPI fluorescence (blue) image may shift in the Z-axis direction due to axial chromatic aberration. With VC objective lens, on the other hand, as axial chromatic aberration has been corrected up to the violet range, DAPI fluorescence (blue) image shift in Z-axis direction is corrected and it is clearly seen that nucleus stained with DAPI is properly in a cell.

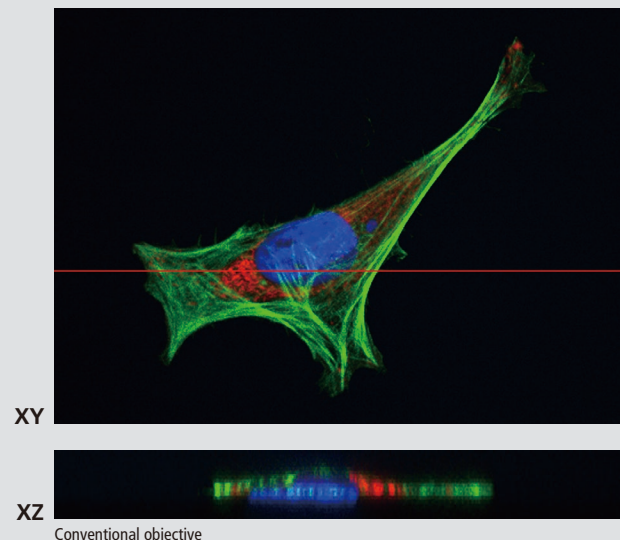
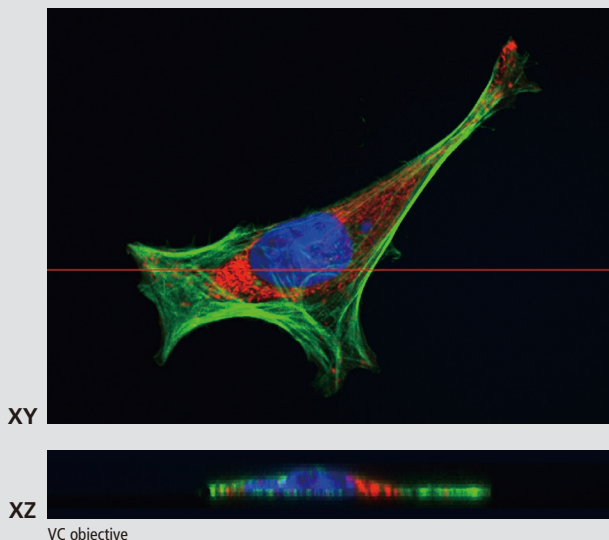

Fluorescence image of actin (green: Alexa 488, excitation: 488nm), mitochondria (red: Mito Tracker Organe, excitation: 543nm) and nucleus (blue: DAPI, excitation: 408nm) of HeLa cell. Consecutive cross-sectional XY and XZ images acquired with a confocal laser microscope and CFI Plan Apochromat VC 100x oil objective.

## Water-dipping Objective Series

### New design for enhanced operability

- Long WD and high NA at any magnification.
- Sharper tips and broad approach angles provide improved accessibility for manipulator control.
- Aberrations are corrected even in the infra-red range with the high-magnification objectives, making them suitable for multi-photon imaging using infra-red light.
- 100xW objective with a correction ring that corrects spherical aberration induced by imaging depth or temperature fluctuations. With excellent infra-red transmission, this lens assures best quality images of even a thick specimen.



CFI Plan Fluor 10x W, NA 0.3, WD 3.5mm

CFI75 LWD 16x W, NA 0.8, WD 3.0mm

CFI Apochromat 40x W NIR, NA 0.8, WD 3.5mm

CFI Apochromat 60x W NIR, NA 1.0, WD 2.8mm

CFI Plan 100x W, NA 1.1, WD 2.5mm

### Water-dipping objective with low magnification, high NA and long working distance CFI75 LWD 16xW

#### Single objective covers a wide range of magnifications

- The 16x objective, when combined with FN1 microscope and dedicated magnification module, provides 5.6x, 32x, and 64x magnifications. As this single objective allows observation from a low magnification wide field to a high magnification high resolution field, it is ideal for patch-clamp experiments.
- With excellent IR transmission, this lens is also suitable for IR-DIC observation.
- With its high NA, the 16x objective provides superb image quality in combination with confocal laser microscopes

- Ultrawide field of view of 2mm (magnification 5.6x) and wide 45° approach angle make the manipulator control and positioning easy.

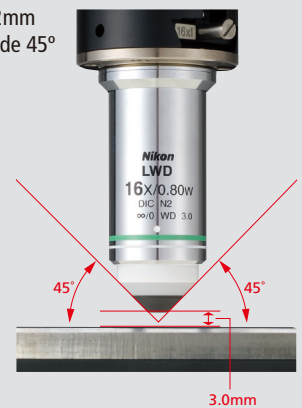

16x objective can be used only in combination with a FN1 microscope and single objective holder.



5.6x (magnification 0.35x)

32x (magnification 2x)

64x (magnification 4x)

Photos courtesy of: Dr. Hiroyoshi Miyakawa, Tokyo University of Pharmacy and Life Sciences

## High-sensitivity Apodization Objective for Phase Contrast

### Contrast doubled by reduction in halo

- The employment of an apodization phase ring reduces halo, which lowers the quality of phase contrast images. This improves the contrast of images to twice that achieved by a conventional product. This lens enables high-resolution observation of the minute structure in an unstained, low-contrast intracellular structure.
- With its high NA, this lens is also suitable for fluorescence observation.
- This lens is suitable for observation of the unstained structure and organelle of cultured cells as well as time-lapse observation of mitochondrial transport, growth cone and stress fiber.



CFI Plan Fluor ADH 100x oil, NA 1.30

#### Comparison with a conventional phase contrast objective

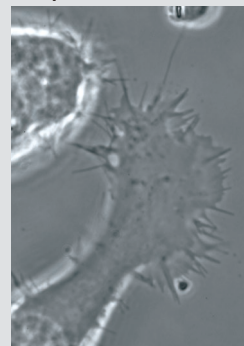

NG108-15 cell captured by CFI Plan Fluor ADH 100x oil objective.

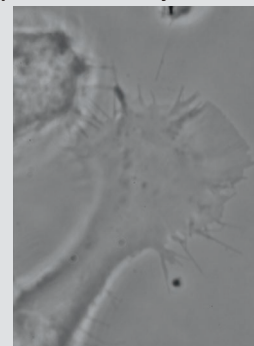

The same cell captured by conventional phase contrast objective (CFI Plan Fluor DLL 100x oil).

Images: from The 29th Optics Symposium (2004, Tokyo) 43-46

Photos courtesy of: Dr. Kaoru Kato, the National Institute of Advanced Industrial Science and Technology (AIST)

References: Kaoru Kato, Tatsuro Ohtaki, Motohiro Suzuki (2004) Biophysics Vol 44, No 6, 260-264

## Objectives for brightfield observation



### CFI Plan Apochromat Series

These high NA series feature superior image flatness and resolving power at the theoretical limit of today's optical technology and are designed to correct all optical aberrations throughout the visible spectrum, from violet to red over the entire 25 mm field of view. The  $\lambda$  series has high transmission rates and chromatic aberration correction up to near-infrared range, while the VC series corrects chromatic aberrations from 405 nm.



### CFI S Fluor Series

This CFI S Fluor series ensures a high transmission rate of ultraviolet wavelengths down to 340 nm for fluorochromes like indo-1, fura-2 and fluo-3. Also, these objectives have improved S/N ratios for short wavelengths and have high NA, making the fluorescence images they produce significantly sharper and brighter.



### CFI Achromat Series

Correction of chromatic aberration, spherical aberration and coma has been dramatically improved, with significantly better image flatness across the 22mm field of view.



### CFI Plan Fluor Series

Featuring an extra-high transmission rate, especially in the ultraviolet wavelength, and flatness of field, this series is designed for fluorescence observation and imaging. These objectives can function as multi-purpose objectives for brightfield, fluorescence, polarizing, and DIC observations.



### CFI Plan Achromat Series

Nikon's CFI Plan Achromat series provides incredible image flatness over the entire 25mm field of view, with chromatic aberration corrected throughout the entire visible spectrum. These objectives are suitable not only for observation but also for capturing images.

## Objectives for advanced modulation contrast observation



CFI S Plan Fluor ELWD NAMC series



CFI Achromat NAMC series

### Nikon Advanced Modulation Contrast

Nikon has developed dedicated objectives for advanced modulation contrast. Colorless and transparent samples can be observed in high relief with a plastic dish, which is not possible in DIC observation. The direction of contrast can be matched to S Plan Fluor ELWD NAMC objectives, thereby allowing optimal contrast selection for techniques like microinjection and ICSI.

## Objectives for phase contrast observation

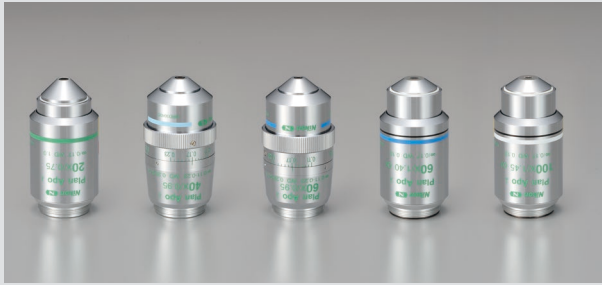

### CFI Plan Apochromat Series for Phase Contrast

The  $\lambda$  series' transmission rates and correction of chromatic aberrations have been improved and extended up to the near-infrared range. High NA, exceptional brightness, comprehensive aberration correction and superior flatness of field of view make these lenses ideal for the most demanding research projects.



### CFI Plan Fluor Series for Phase Contrast

These objectives are multi-purpose; they can be used for brightfield, fluorescence, or phase contrast observations. They facilitate high-quality fluorescence observation and provide exceptionally detailed resolution of minute structures in phase contrast. The use of phase contrast to find the desired portion of the specimen before switching to fluorescence observation is an excellent way to minimize fluorescence photo bleaching.



### CFI Plan Achromat Series for Phase Contrast

Nikon's CFI Plan Achromat series provides incredible image flatness over the entire 25mm field of view, with chromatic aberration corrected throughout the entire visible spectrum. With incredible image sharpness, these objectives can be used for laboratory work as well as exacting research.



### CFI Achromat Series for Phase Contrast

Correction for chromatic aberration in this series has been dramatically improved and is now at the same level as the CFI Plan Achromat Series. These objectives now boast performance far outstripping their cost.

## Objectives for apodized phase contrast observation



### Apodized Phase Contrast Series

Nikon specifically developed this series for phase contrast observations by using its proprietary Apodization process to improve the objective's phase ring. Cell division activities taking place within a specimen—hitherto often obscured by unwanted halos—can now be observed more clearly.

## Objectives for inverted microscope Ti



For brightfield and DIC observations



For phase contrast observation

### CFI S Plan Fluor ELWD Series

Newly developed broadband multilayer coating realizes high transmittance from near-ultraviolet ( $\text{Ca}^{2+}$ ) to near-infrared wavelengths, with improved chromatic correction. The correction collar ring allows these objectives to be used with a diverse range of culture vessels and specimen thicknesses. High-quality images with no aberrations can be obtained under a broad range of illumination techniques.

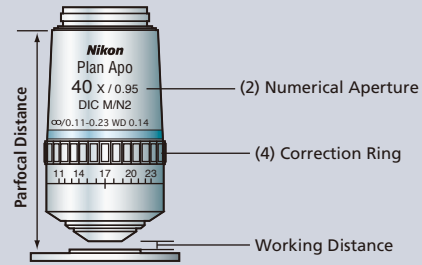
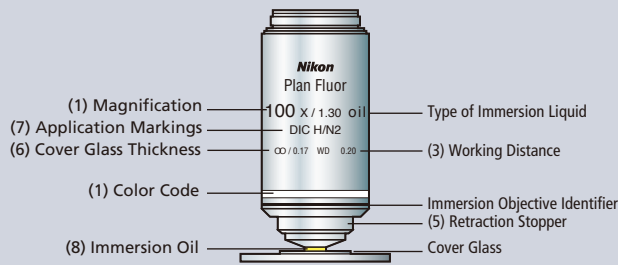

Nikon offers a wide variety of CFI objectives. To assist the user they are clearly marked with information on the objective barrel such as: which DIC module or Phase Ring to use.

### (1) Magnification and Color Code

A color coded ring on the barrel identifies the magnification of the objective:

Mag.	1x	2x	4x	10x	20x	40x	50x	60x	100x
Color code	Black	Gray	Red	Yellow	Green	Light Blue	Light Blue	Cobalt Blue	White

### (2) Numerical Aperture (NA)

NA is the most important factor in defining the performance characteristics of an objective.

$$NA = n \sin \theta$$

n: the refractive index of the media at d-line (587nm)

For dry objective n=1.000 (air)

For oil immersion objective n = 1.515 (oil)

For water immersion objective n = 1.333 (water)

$\theta$  : Angle of half the cone of incident light that can enter or exit the top lens of the objective

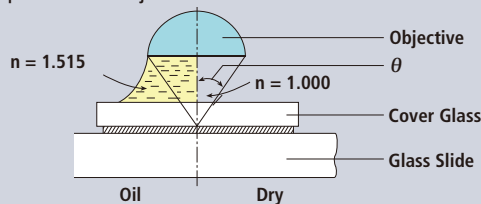

The higher the NA, the higher the resolving power.

When the resolving power is defined as the power to distinguish the two points,

$$R = 0.61 \frac{\lambda}{NA}$$

If  $\lambda = 0.55 \mu\text{m}$  (Green light) and  $NA = 1.4$ ,  
resolving power (R) =  $0.61 \frac{0.55}{1.4} = 0.24 \mu\text{m}$

The higher the NA the brighter image.

$$\text{Brightness: } B \propto \left\{ \frac{NA}{\text{Total Magnification}} \right\}^2$$

The higher the NA, the shallower the depth of focus (DOF).

$$DOF = \frac{n \lambda}{2NA^2}$$

### (3) Working Distance

Working distance (WD) defines the distance between the top lens of the objective and the surface of the cover glass.

CFI60 objectives can offer longer working distance with high numerical aperture.

### (4) Correction Ring

Dry objectives with high Numerical Aperture are susceptible to spherical and other aberrations which can impair resolution and contrast when used with a cover glass whose thickness differs from the specified value. A 1 1/2 cover glass (0.17mm thick) should be used as standard, however not all 1 1/2 cover glasses

are exactly 0.17mm and many specimens have media between them and the cover glass. The correction ring is used to adjust for these subtle differences to ensure the optimum objective performance.

### How to use the correction ring

- Position the ring at 0.17. The thickness of the standard cover glass is 0.17mm.
- Focus the lens on a small artifact in the specimen.
- Rotate the ring very slightly and focus the lens again to check if the image has improved or degraded.
- Repeat the above step to determine if the image is improving or degrading in the direction you are turning the ring.
- If the image has degraded, follow the same procedure in the opposite direction to find the position offering optimum resolving power and contrast.

### (5) Retraction Stopper

Some objectives for oil immersion have a retraction stopper. In order to prevent clean slides from being accidentally smeared with immersion oil, the retraction assembly can be engaged by pushing in the front element and twisting it to the right. This will lock the objective in the up position so it will not leave immersion oil on a clean slide as the nosepiece is rotated. Twisting to the left will release the retracted objective for use.

### (6) Cover Glass Thickness

For optimum performance, the thickness of the cover glass should be 0.17mm. For example, at NA=0.95, a 0.01mm difference in thickness reduces image formation by 45% from the ideal image.

NA	Difference in cover glass thickness	
	0.01mm	0.02mm
0.3	100%	100%
0.45	100	100
0.7	98	92
0.85	81	43
0.95	45	29

### (7) Application Markings

DIC: for differential interference contrast

DM: for phase contrast, dark contrast middle type

DL: for phase contrast, dark contrast light type

DLL: for phase contrast, lower contrast type

P: for polarizing

NCG: for use without cover glass

### (8) Immersion Oil

After using immersion oil, gently blot the lens dry with lens tissue. Then slightly moisten a piece of lens tissue with petroleum benzene (Naphtha) and clean off all traces of the oil from the immersion objective. Cleaning is essential for water immersion objectives as well; after use, wipe the water off the top lens.

# CFI60 Objectives

Type	Use	Model	Immersion	NA	WD (mm)	Cover glass thickness	Correction ring	Spring loaded	Brightfield	Darkfield	DIC	Phase contrast	Polarizing	Fluorescence		Ti-E PFS	
														Visible light	UV		
Achromat	Brightfield (CFI)	4x		0.10	30.00	—			⊙				△	○			
		10x		0.25	7.00	—			⊙	△			△	○			
		10x DS		0.25	7.00	—			⊙				△	○			
		LWD 20x		0.40	3.90	0.17			⊙	○●			△	○			
		40x		0.65	0.65	0.17		✓	⊙	○●			△	○			
		LWD 40xC		0.55	2.7-1.7	0-2.0	✓		⊙	○●			△	○			
		60x		0.80	0.30	0.17		✓	⊙	●			△	○			
		100x Oil	Oil	1.25	0.23	0.17		✓	⊙				△	○			
	100xSH (with iris)	Oil	0.5-1.25	0.23	0.17		✓	⊙	○●			△	○				
	Polarizing (CFI)	P 4x		0.10	30.00	—				⊙			⊙	○			
		P 10x		0.25	7.00	—				⊙	△		⊙	○			
		LWD P 20x		0.40	3.90	0.17				⊙	○●		⊙	○			
		P 40x		0.65	0.65	0.17		✓		⊙	○●		⊙	○			
		P 100x Oil	Oil	1.25	0.23	0.17		✓		⊙			⊙	○			
	Phase contrast (CFI)	DL 10x		0.25	7.00	—				○	△		⊙ PH1	△	△		
		LWD DL 20x		0.40	3.90	0.17				○	○●		⊙ PH1	△	△		
		LWD DL 20xF		0.40	3.10	1.2				○			⊙ PH1	△	△		
		DL 40x		0.65	0.65	0.17		✓		○	○●		⊙ PH2	△	△		
		LWD DL 40x		0.55	2.7-1.7	0-2.0	✓			○	○●		⊙ PH2	△	△		
		DL 100x Oil	Oil	1.25	0.23	0.17		✓		○			⊙ PH3	△	△		
		BM 10x		0.25	7.00	0.7				○			⊙ PH1	△	△		
	Apodized phase contrast (CFI)	ADL 10x		0.25	6.20	1.2				○			⊙ PH1	△	△		
		LWD ADL 20xF		0.40	3.10	1.2				○			⊙ PH1	△	△		
		LWD ADL 40xF		0.55	2.10	1.2				○			⊙ PH1	△	△		
		LWD ADL 40xC		0.55	2.7-1.7	0-2.0	✓			○	○●		⊙ PH2	△	△		
	Advanced modulation contrast (CFI)	NAMC 10x		0.25	6.20	1.2				○					△		
		LWD NAMC 20xF		0.40	3.10	1.2				○					△		
		LWD NAMC 40xC		0.55	2.7-1.7	0-2.0	✓			○					△		
	Plan Achromat	Brightfield (CFI Plan)	UW 1x		0.04	3.20	—			⊙				△	△		
			UW 2x		0.06	7.50	—			⊙				△	△		
4x				0.10	30.00	—			⊙				△	○			
10x				0.25	10.50	—			⊙	△			△	○			
20x				0.40	1.20	0.17			⊙	○●			△	○			
40x				0.65	0.56	0.17		✓	⊙	○●			△	○			
50x Oil			Oil	0.90	0.20	0.17		✓	⊙	●			△	○			
100x Oil			Oil	1.25	0.20	0.17		✓	⊙				△	○			
LWD IMSI 100xC				0.85	1.3-0.95	0.6-1.3	✓		⊙			○*2			○		
Phase contrast (CFI Plan)			DL 10x		0.25	10.50	—				○	△		⊙ PH1	△	△	
		DL 20x		0.40	1.20	0.17				○	○●		⊙ PH1	△	△		
		DL 40x		0.65	0.56	0.17		✓		○	○●		⊙ PH2	△	△		
		DL 100x Oil	Oil	1.25	0.20	0.17		✓		○			⊙ PH3	△	△		
No cover glass (CFI Plan)		NCG 40x		0.65	0.48	0		✓	⊙	○●				△	○		
		NCG 100x		0.90	0.26	0		✓	⊙	●				△	○		
Super long WD (CFI L Plan EPI)		SLWD 20x		0.35	24.00	0			⊙	○●				△	○		
		SLWD 50x		0.45	17.00	0			⊙	○●				△	○		
		SLWD 100x		0.70	6.50	0			⊙	○●				△	○		
S Plan Fluor		Brightfield (CFI S Plan Fluor)	ELWD 20xC		0.45	8.2-6.9	0-2.0	✓		⊙	○●	○		○	○	○	●
			ELWD 40xC		0.60	3.6-2.8	0-2.0	✓		⊙	○●	○		○	○	○	●
	ELWD 60xC			0.70	2.6-1.8	0.1-1.3	✓		⊙	○●	○		○	○	○	●	
	Apodized phase contrast (CFI S Plan Fluor)	ELWD ADM 20xC		0.45	8.2-6.9	0-2.0	✓		○	○●		⊙ PH1		○	○	●	
		ELWD ADM 40xC		0.60	3.6-2.8	0-2.0	✓		○	○●		⊙ PH2		○	○	●	
		ELWD ADL 60xC		0.70	2.6-1.8	0.1-1.3	✓		○	○●		⊙ PH2		○	○	●	
Advanced modulation contrast (CFI S Plan Fluor)	ELWD NAMC 20xC		0.45	7.40	0-2.0	✓		○						○			
	ELWD NAMC 40xC		0.60	3.10	0-2.0	✓		○						○			
S Fluor	Brightfield (CFI S Fluor)	4x		0.20	15.50	—			⊙				△	○	⊙ Wide	●	
		10x		0.50	1.20	0.17		✓	⊙	○●	○		△	○	⊙ Wide	●	
		20x		0.75	1.00	0.17		✓	⊙	○●	○		△	○	⊙ Wide	●	
		40x		0.90	0.30	0.11-0.23	✓	✓	⊙	○●	○		△	○	⊙ Wide	●	
		40x Oil	Oil	1.30	0.22	0.17		✓ w/stopper	⊙	●	○		△	○	⊙ Wide	●	
		100xSH (with iris)	Oil	0.5-1.3	0.20	0.17		✓	⊙	○●			△	○	⊙ Wide		
Universal Plan Fluor	No cover glass polarizing (CFI LU Plan Fluor EPI)	P 5x		0.15	23.50	—			⊙				⊙	○	○		
		P 10x		0.30	17.50	0			⊙	△			⊙	○	○		
		P 20x		0.45	4.50	0			⊙	○●			⊙	○	○		
		P 50x		0.80	1.00	0		✓	⊙	●			⊙	○	○		
		P 100x		0.90	1.00	0		✓	⊙	●			⊙	○	○		

\*1 Compatible with IMSI only      \*2 Dedicated for FN1 (CFI75 objective)

### Note 1. Model numbers

The below letters, when attached to the end of model numbers, indicate the respective features.

F: for use with 1.2mm-thick cover glass      SH: with iris      MI: multi immersion (oil, water, glycerin) type  
 C: with correction ring      W: water immersion type      IMSI: compatible with IMSI only  
 NCG: for use without cover glass      W: water dipping type      DS: compatible with dispersion staining microscopy

### Note 2. Cover glass thickness

— : can be used without cover glass  
 ○ : use without cover glass

### Note 3. Darkfield microscopy

Possible with the following  
 △ : universal condenser (dry) and darkfield ring  
 ○ : above and darkfield condenser (dry)  
 ● : darkfield condenser (oil)

Note 4. Phase rings are classified by objective NA  
 PH1 and PH2 - 3 are condenser cassette modules. EXT PH3  
 and EXT PH4 indicate external phase contrast modules for Ti.

### Note 5. Fluorescence microscopy (UV)

△ : possible with visible light that has a longer  
 wavelength than the excitation light used for DAPI  
 ○ : suitable

⊙ : recommended for best results  
 Wide: high transmittance with an ultraviolet  
 wavelength range of up to 340nm

Type	Use	Model	Immersion	NA	WD (mm)	Cover glass thickness	Correction ring	Spring loaded	Brightfield	Darkfield	DIC	Phase contrast	Polarizing	Fluorescence			TI-E PFS	
														Visible light	UV	NIR		
Plan Fluor	Brightfield (CFI Plan Fluor)	4x		0.13	17.20	—			⊙				△	⊙	⊙			
		10x		0.30	16.00	0.17			⊙	△	○		○	⊙	⊙		●	
		20x		0.50	2.10	0.17			⊙	○●	○		○	⊙	⊙			
		20xA MI	Oil, water glycerin,	0.75	0.51-0.35 0.51-0.34 0.49-0.33	0-0.17	✓	✓	⊙	○●	○		○	⊙	⊙			
		40x		0.75	0.66	0.17		✓	⊙	○●	○		○	⊙	⊙		●	
		40x DS2		0.75	0.66	0.17		✓	○					○	○			
		40x Oil	Oil	1.30	0.20	0.17		✓w/stopper	⊙			○	EXT PH3-40x	○	⊙	⊙	●	
		60x		0.85	0.40-0.31	0.11-0.23	✓	✓	⊙	●	○		○	⊙	⊙			
		60xSH (with iris)	Oil	0.50-1.25	0.22	0.17		✓	⊙	○●	○		○	⊙	⊙			
	100x Oil	Oil	1.30	0.16	0.17		✓w/stopper	⊙			○	○	⊙	⊙		●		
	100xSH (with iris)	Oil	0.50-1.30	0.20	0.17		✓	⊙	○●	○		○	⊙	⊙				
	Phase contrast (CFI Plan Fluor)	DL 4x		0.13	16.40	1.2			○				◎ PHL		○	○		
		DLL 10x		0.30	16.00	0.17			○	△			◎ PH1		○	○	●	
		DL 10x		0.30	15.20	1.2			○	△			◎ PH1		○	○		
		DLL 20x		0.50	2.10	0.17			○	○●			◎ PH1		○	○		
		DLL 40x		0.75	0.66	0.17			○	○●			◎ PH2		○	○	●	
		DM 40xDS		0.75	0.66	0.17			○	○●			◎ PH2		○	○		
		DLL 100x Oil	Oil	1.30	0.16	0.17			○	○			◎ PH3		○	○	●	
		BM 40x AS		0.75	0.66	0.17			○				◎ PH2		○	○		
Apodized phase contrast (CFI Plan Fluor)	ADH 100x Oil	Oil	1.30	0.16	0.17			○	○			◎ PH3		○	○	●		
Plan Achromat	Brightfield (CFI Plan Apo)	λ 2x		0.10	8.50	—			⊙				○	⊙	△	⊙		
		λ 4x		0.20	20.00	—			⊙				○	⊙	△	⊙	●	
		λ 10x		0.45	4.00	0.17			⊙	△	○		○	⊙	△	⊙	●	
		λ 20x		0.75	1.00	0.17			✓	⊙	○●	○		○	⊙	△	⊙	●
		VC 20x		0.75	1.00	0.17			✓	⊙	○●	○		○	⊙	△	●	
		λ 40x		0.95	0.21 (0.25-0.16)	0.11-0.23	✓	✓	⊙	●	○			○	⊙	△	⊙	●
		λ 60x		0.95	0.15 (0.21-0.11)	0.11-0.23	✓	✓	⊙	●	○			○	⊙	△	⊙	
		λ 60x Oil	Oil	1.40	0.13	0.17			✓	⊙		○	EXT PH3-60x	○	⊙	△	⊙	●
		VC 60x WI	Water	1.20	0.31-0.28	0.15-0.18	✓	✓	⊙	●	○		EXT PH3-60x	○	⊙	⊙		●
		IR 60x WI	Water	1.27	0.17 (0.18-0.16)	0.15-0.19	✓	✓	⊙		○		EXT PH3-60x	○	○	△	⊙	●
		λ 100x Oil	Oil	1.45	0.13	0.17			✓	⊙		○	EXT PH3-100x	○	⊙	△	⊙	●
		VC 100x Oil	Oil	1.40	0.13	0.17			✓	⊙		○	EXT PH3-100x	○	⊙	△		●
	HP VC 100x Oil	Oil	1.40	0.13	0.17			✓	⊙		○	EXT PH3-100x	○	⊙	△		●	
	NCG 100x Oil	Oil	1.40	0.16	0			✓	⊙		○		○	⊙	△			
	SR (CFI SR Plan Apo)	IR 60x WI	Water	1.27	0.17 (0.18-0.16)	0.15-0.19	✓	✓	⊙		○	EXT PH3-60x	○	○	△	⊙	●	
	Phase contrast (CFI Plan Apo)	λ DM 20x		0.75	1.00	0.17			✓	○	○●		◎PH2		○	△	○	●
		λ DM 40x		0.95	0.21 (0.25-0.16)	0.11-0.23	✓	✓	○	●			◎PH2		○	△	○	●
λ DM 60x			0.95	0.15 (0.21-0.11)	0.11-0.23	✓	✓	○	●			◎PH2		○	△	○		
λ DM 60x Oil		Oil	1.40	0.13	0.17			✓	○			◎PH3		○	△	○	●	
λ DM 100x Oil		Oil	1.45	0.13	0.17			✓	○			◎PH3		○	△	○	●	
Achromat	Confocal (CFI Apo)	LWD 20x WI λS	Water	0.95	0.95	0.11-0.23	✓		⊙	●	○		○	○		○	●	
		40x WI λS	Water	1.25	0.18	0.15-0.19	✓	✓	⊙		○	EXT PH3-40x	○	⊙	⊙		●	
		LWD 40x WI λS	Water	1.15	0.60	0.15-0.19	✓	✓	⊙	●	○	EXT PH3-40x	○	⊙	○		●	
	60x Oil λS	Oil	1.40	0.14	0.17			✓	⊙		○	EXT PH3-60x	○	⊙	⊙		●	
	Evanescent (CFI Apo)	TIRF 60x Oil	Oil	1.49	0.12	0.13-0.19 (23°C) 0.15-0.21 (37°C)	✓		⊙		○	EXT PH4-60x	○	⊙	△		●	
		TIRF 100x Oil	Oil	1.49	0.12	0.13-0.19 (23°C) 0.14-0.20 (37°C)	✓		⊙		○	EXT PH4-100x	○	⊙	△		●	
		HP TIRF 100x Oil	Oil	1.49	0.12	0.13-0.19 (23°C) 0.14-0.20 (37°C)	✓		⊙		○	EXT PH4-100x	○	⊙	△		●	
	SR (CFI SR Apo)	TIRF 100x Oil	Oil	1.49	0.12	0.13-0.19 (23°C) 0.14-0.20 (37°C)	✓		⊙		○	EXT PH4-100x	○	⊙	△		●	
Water Dipping	Confocal (CFI Apo)	25xW MP	Water	1.10	2.00	0	✓		⊙	●	○		○	⊙	○	○		
		25xW MP1300	Water	1.10	2.00	0	✓		⊙	●	○		○	⊙	○	○		
	Brightfield (CFI Plan Fluor)	10xW	Water	0.30	3.50	0			⊙	△	○		○	⊙	⊙	○		
		20xW	Water	0.50	2.00	0			⊙	○●	○		○	⊙	⊙	○		
		40xW	Water	0.80	2.00	0			⊙	●	○		○	⊙	⊙	Wide	○	
	60xW	Water	1.00	2.00	0			⊙	●	○		○	⊙	⊙	○			
	Brightfield (CFI Apo)	40xW NIR	Water	0.80	3.50	0			⊙	●	○		○	⊙	△		⊙	
		60xW NIR	Water	1.00	2.80	0			⊙	●	○		○	⊙			⊙	
	Brightfield (CFI Plan)	100xW	Water	1.10	2.50	0		✓	⊙	●	○		○	⊙			○	
		Phase contrast (CFI Fluor)	DLL 40xW	Water	0.80	2.00	0			○	●		◎ PH2		○	○	○	
Brightfield (CFI75)	LWD 16xW*2	Water	0.80	3.00	0			⊙	●	○			○	⊙	○	○		

Note 6. Brightfield/DIC/Fluorescence (visible light) microscopy  
 △ : possible but not recommended  
 ○ : suitable  
 ◎ : recommended for best results

Note 7. Polarizing  
 △ : possible but not recommended  
 ○ : suitable  
 ◎ : retardation measurement is possible with a polarizing microscope

Note 8. TI-E PFS  
 ● : compatible with PFS

 is marked on the surface of objectives that employ Nano Crystal Coat.

Company names and product names appearing in this brochure are their registered trademarks or trademarks.  
N.B. Export of the products\* in this brochure is controlled under the Japanese Foreign Exchange and Foreign Trade Law.  
Appropriate export procedure shall be required in case of export from Japan.  
\*Products: Hardware and its technical information (including software)  
Monitor images are simulated.

Specifications and equipment are subject to change without any notice or obligation on the part of the manufacturer. March 2016 ©1998-2016 NIKON CORPORATION



**WARNING**

TO ENSURE CORRECT USAGE, READ THE CORRESPONDING MANUALS CAREFULLY BEFORE USING YOUR EQUIPMENT.



#### NIKON CORPORATION

Shinagawa Intercity Tower C, 2-15-3, Konan, Minato-ku, Tokyo 108-6290, Japan  
phone: +81-3-6433-3705 fax: +81-3-6433-3785  
<http://www.nikon.com/products/microscope-solutions/>

ISO 14001 Certified  
for NIKON CORPORATION

#### NIKON INSTRUMENTS INC.

1300 Walt Whitman Road, Melville, N.Y. 11747-3064, U.S.A.  
phone: +1-631-547-8500; +1-800-52-NIKON (within the U.S.A. only)  
fax: +1-631-547-0306

<http://www.nikoninstruments.com/>

#### NIKON INSTRUMENTS EUROPE B.V.

Tripolis 100, Burgerweeshuispad 101, 1076 ER Amsterdam, The Netherlands  
phone: +31-20-7099-0000 fax: +31-20-7099-298  
<http://www.nikoninstruments.eu/>

#### NIKON INSTRUMENTS (SHANGHAI) CO., LTD.

CHINA phone: +86-21-6841-2050 fax: +86-21-6841-2060  
(Beijing branch) phone: +86-10-5831-2028 fax: +86-10-5831-2026  
(Guangzhou branch) phone: +86-20-3882-0550 fax: +86-20-3882-0580

#### NIKON CANADA INC.

CANADA phone: +1-905-602-9676 fax: +1-905-602-9953

#### NIKON FRANCE S.A.S.

FRANCE phone: +33-1-4516-45-16 fax: +33-1-4516-45-55

#### NIKON GMBH

GERMANY phone: +49-211-941-42-20 fax: +49-211-941-43-22

#### NIKON INSTRUMENTS S.p.A.

ITALY phone: +39-55-300-96-01 fax: +39-55-30-09-93

#### NIKON GMBH SWITZERLAND

SWITZERLAND phone: +41-43-277-28-67 fax: +41-43-277-28-61

#### NIKON UK LTD.

UNITED KINGDOM phone: +44-208-247-1717 fax: +44-208-541-4584

#### NIKON CEE GMBH

AUSTRIA phone: +43-1-972-6111 fax: +43-1-972-611-140

#### NIKON SINGAPORE PTE LTD

SINGAPORE phone: +65-6559-3651 fax: +65-6559-3668

#### NIKON INSTRUMENTS KOREA CO., LTD.

KOREA phone: +82-2-2186-8400 fax: +82-2-555-4415